

Research Article

Digitalize Learning via Process Simulation to Understand Process Control

Gouws S*

Department of Chemistry, Nelson Mandela University, Summerstrand, Gqeberha, South Africa

***Corresponding author:** Shawn Gouws, Department of Chemistry, Nelson Mandela University, Summerstrand, Gqeberha, South Africa**Received:** October 20, 2022; **Accepted:** November 22, 2022; **Published:** November 29, 2022**Abstract**

Process simulation has become an important tool in training chemical engineers, operators in the chemical and industry sectors. Although various process simulation tools are available, in this study the software from Simulation Solutions. Inc. was used. This dual screen approach for student training consists of outside field operation view with interacting digital equipment and with the 2nd screen, the students can be in the control room environment changing input values. This provides the students with training in both control room adjustments of the plant and field operations adjustments. Students are supplied with a student manual that consist of Pipe and Instrument Diagrams (P&ID), standard operating procedures and troubleshooting exercises which they can follow. This article will discuss how these students benefit from process simulation training and how “What- ifs” can be used to pinpoint a potential problem. Once a problem has been identified then through simulation, the students will implement a corrective plan to successfully mitigate the risk. The feedbacks from the students suggest they have thoroughly enjoyed the interaction with the process simulation software and the “What-if” scenarios to identify the problem and use various resources to mitigate the problem. They learn how to implement strategies, solve the problem successfully and continue with the production process.

Keywords: Process simulation; Skills acquisition; Digital learning; Problem solving; Technology-enhanced learning

Abbreviations

A: Surface Area / M²; Cp: Specific Heat Capacity; DCS: Distributed Control System; F: Friction; FC: Flow Controller; HAZOP: Hazardous Operations; Iot: Internet Of Things; LC: Level Controller; M: Mass Flow Rate; MPC: Multivariable Process Control; PFD: Process Flow Diagram; PID: Proportional, Integration And Differentiation; P&ID: Pipe And Identification Drawings; Q: Heat Coefficient; SOP: Standard Operating Procedure; SPC: Statistical Process Control; ΔT : Temperature Change Between Inlet And Outlet; ΔT_{ln} : Log Mean Temperature Difference; U: Overall Heat Co-Efficiency; UV Sonar: Ultraviolet Sonar Level Sensor; WIL: Work Ingrate Learning

Introduction

Process simulation software [1] has been widely used by chemical engineers over the last decade to design a chemical plant, test and optimized the various process to ensure optimum production and minimization of waste. [2,3] With the aid of simulation technology software, students can be trained to build competence to operate a chemical plant. These tools have demonstrated an increase in awareness and an increase in their capabilities to perform their work in a chemical plant workspace.

Online teaching has become one of the major teaching mechanisms of today's age [4,5] where technologies are around us such as Internet of Things (IoT) [6] that include smart phones and the Apps utilized on these devices, Tablets with touch button sensor screens make the technology user friendly. This allows for real time

monitoring of process variables such as temperature, pressure, flow rate and levels. Artificial intelligence [7] (AI) has been utilized in a chemical plant for years to measure and monitor potential areas to mitigate risks or consequences. A challenge the students face in Diploma Chemical Process Technology program was that their training in the course was 2-dimentional. In the sense training chemical process operators in a theory class from PowerPoint slides was good to a point, but concepts and illustration of a chemical plant was not covered in such a way that the learner could leave with a good understanding but had to rely on their imagination and pictures of the equipment. Too enhance learning, simulation companies were approached to purchase an existing software package to train students in various plant procedures. Procedures that involve risk management, hazardous operations (HAZOPs), start-ups and shut-downs, mitigation of potential harm that could lead to a catastrophic event are included.

Although these students have sound knowledge in the mathematics aspects of basic process engineering and process equipment, it comes down to practical understanding of industrial process control. Therefore, it is important convert practical knowledge into practical understanding of process control loops, [8] concepts, and problem solving/troubleshooting solutions [9]. Process control has several advantages in a chemical production plant, 1) the reduction of operation cost, there might be an initial capital cost in acquiring the distributed control systems, followed by traditional and advance process control to the optimization and real-time process control systems. Secondly, to maximize profitability of the desired

product to be maintained throughout the process with minimization of by-products or waste streams products.

In a classroom environment, the students are introduced to basic and advanced process control systems to develop understanding as to how a process control loop function, and how to mitigate risks associated with the process. The basic process control module covers various variable such as temperature, pressure, level, and flow. How these variables interact with one another and how the different variables operate in a cascade system to improve the process performance. Other aspects of tuning in open and close system [10] being discussed to aspects of Multivariable Process Control (MPC) and different algorithms in the process control Proportional, Integration, and Differentiation (PID) make the sense flows better.

To bridge the gap between theory and practical's, various practical objective was developed and implemented. Three process equipment modules were chosen as process simulation tools such as heat exchanger, fluid flow and centrifugal pumps to study the process with which the students can interact. This takes place in a control room or from an outside/field operators' perspective. The student then needs to discuss, as part of the objective, the operation mode involved in the process control.

What variables could be direct or indirectly manipulated and measured to meet the specific criteria of the process and to optimize the process towards the desired product.

Simulation software is used to simulate the operation three different processes such as fluid flow, heat exchanger and centrifugal pumps. This simulation involves identification of components in the plant environment referred to as in the field and control room environment in front of the DCS board (distributed control system). After identification the students discusses faults in the form of "What-ifs". What-ifs are a thought process that provide an opportunity for the student to study the trending graphs and process to discover what could go wrong. The event could have been cause by equipment failure for example a stuck valve, or instrument failure where the sensor does not behave correctly and there are discrepancies between the field readings and the DCS board operator. The next objective for the students training is to set the simulation to cold start up (initiate clean start-up) and work through the start-up SOP (standard operating procedure) to have the system back online from a DCS and a field operator perspective. To have a close look at trending graphs and to act in a fast, cognitive manner to sort out a potential hazard.

The paper will provide evidence of the pedagogy process that was utilized in the learning and teaching of student training to be process operators. Feedback from students that illustrate the positives which students have learned or enjoyed from this module and the negatives in which the module could be improved to ensure a better transfer of knowledge.

Methodology

As part of the Diploma Chemical Process Technology course [11] process control is vital important for operators to understand the intrigued works of a chemical plant. Process control module taught by the author to 20 x 3rd year students in the Diploma Chemical Process Technology course per year as part of a learning and teaching exit

level outcome. After completing their 3rd year modules students then need to complete a Work Ingrate Learning (WIL) with a reputable chemical industry plant. Hence why process simulation is an important part of their training providing a platform where process control in a chemical plant could be understood and practiced.

During this module students will be tasked with several assignments 1) a detailed literature study on process control and HAZOP risks involved in a chemical process. 2) to draw a chemical plant by making use of MS Visio 2019 to design and layout a chemical Process Flow Diagram (PFD) and include the Pipe & Identification Drawings (P&ID). The students then need to discuss the strategy involved regarding measurements and manipulations to understand process control in a chemical plant. 3) to utilize software required from PetroSkills – Simulation Solutions [12] to perform cold starts, shut down solving troubleshoot problems that could arise in a chemical plant.

The simulation was taught in 3 sections the 1) on fluid flow, 2) heat exchange and 3) centrifugal pumps these 3 software packages were chosen to provide the students with basic process control that are utilize in most chemical plants. The fluid flow section of the training simulates two tank system, which demonstrates hydrostatic principles. The focus is on pump failures, going from a steady state flow into another tank. Pressures in each tank can be adjusted by split ratio valve controllers. The student then is tasked to do a risk assessment and draft an HAZOP study to identify potential risks and mitigation of these risks. Possible abnormalities that need to be troubleshooted such as instrument failure, equipment failure and human behavior that need to be investigate and mitigate to avoid catastrophic events.

The 2nd section on process simulation is heat exchanger. Heat exchangers are used to heat or cool a process stream. In this simulation water needs to be at a certain temperature for a customer, this is done by passing hot Dowtherm oil through a shell and tube heat exchanger to warm a cold stream of water to the desired temperature. The water and Dowtherm is controlled through flow controllers. The pedagogy involved is to train the students in the operation of heat exchangers from an outside (field) or console perspective. To improve the learner's knowledge of fundamental engineering and operating principles, understanding of basic unit operations and improve basic operational skills.

Students in the diploma trained to be operators or technicians need to meet several learning outcomes such as 1) Describing the basic elements in a control loop, 2) describe which process variables could affect the process by manipulation or measuring the output. 3) to identify primary elements and sensors in a control loop, 4) different mode of controlling the process, 4) basic introduction to various tuning techniques mostly from a communication point to discuss with process engineers, 5) to enable the student to work through "What ifs" scenarios and troubleshoot the problem and then do recommendation to remedy the problem before escalating to a catastrophic event.

"What-ifs" scenarios are a prediction tool we adopted to facilitate the students thinking process. For example, a problem will be given such as pump or instrument failure. The students then need to provide

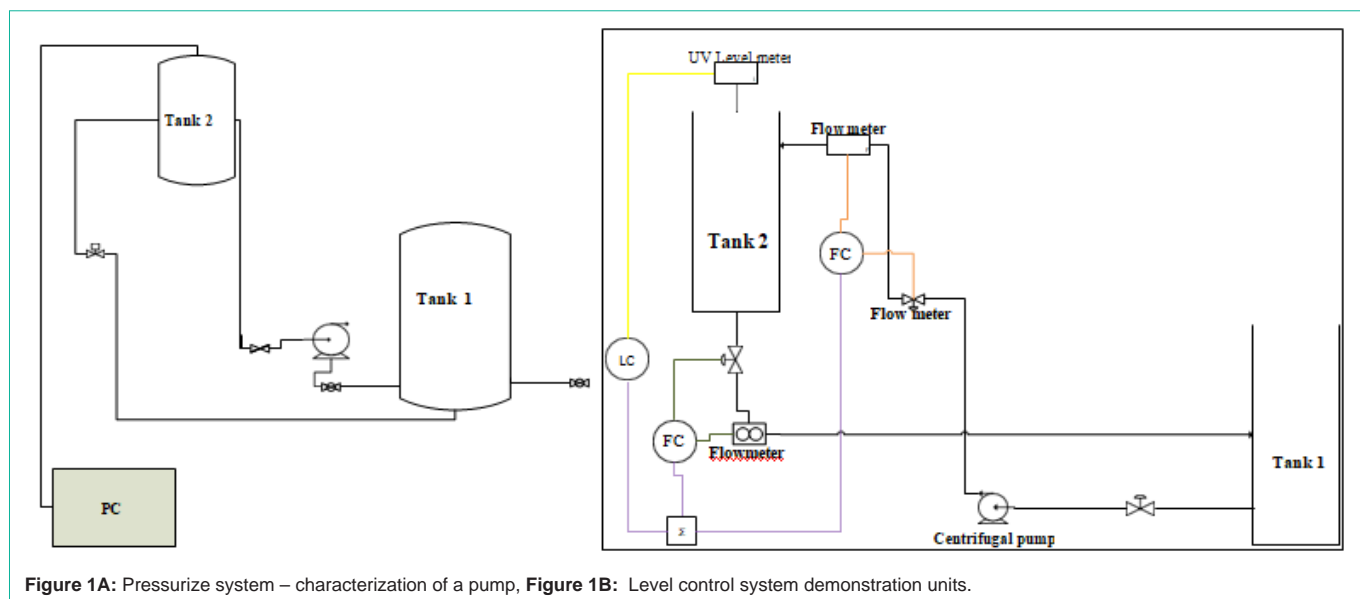

Figure 1A: Pressurize system – characterization of a pump, Figure 1B: Level control system demonstration units.

recommendation of what possibly could go wrong and mitigate a potential solution to avoid a catastrophic consequence.

A questionnaire was distributed to the students to complete to provide feedback of the module presented, the interaction with the supervisor, student interest and overall rating of their performance.

Results and Discussion

Students were instructed to draw four process models in MS Visio, the 1) pressure control systems consisting out of two tanks connected via a centrifugal pump equipped with pressure sensors, a valve and flow controller. 2) a liquid level control system consisting of two tanks connected via a solenoid-controlled butterfly valve and level sensor to monitor the level in the receiving tank. 3) pH control system, consisting of a tank equipped with an inline pH-probe and two dosing pumps. 4) heat exchanger consisting of 4 tanks, flow controllers, thermocouples, and pumps. These 4 P&ID diagrams provide the students with good understanding on how a process control system works, the students then need to report on operational strategy, which variables are measured, and which variables need to be manipulated to control the process and to mitigate potential risks. (Figure 1 A and B) show two process systems A) the pressure system where the students need to characterize a pump and report on the operations, and B) level control system equipped with a UV sonar level sensor. These P&ID drawings teach students to identify components correctly, to write a Standard Operating Procedure (SOP), and to strategies the operational procedure in respect to process control.

The objective from the pressurize system (Figure 1A) is to measure the suction and discharge pressures before and after the pump, to manipulate the flow rate by open and closing a control valve. The speed of the motor on the pump can also be controlled by means of a variable speed controller. From the data collected the braking power and horsepower of the pump can be calculated to determine the net suction pressure and pump efficiency. [13] Most students succeed with the affirmative law calculations but some

struggle, most of the time it is due to conversion errors. (Figure 1B) deals with level control. The object in this task is to perform Statistical Process Control (SPC) at three different stages of valve closure. This place abnormal restrictions on the pump that can starve the pump's capacity to operates. This is important in the pedagogy of the module to teach students about possible pump troubles and how they can mitigate the problem by coming up with a plausible solution.

(Figure 2) shows a student MS Visio drawing for a heat exchange including the process control for the flow sensors and temperature controls. The objects are twofold 1) to manipulate the flow rate of the cold water to observe any absorb duty effects on the hot water system, 2) to control the hot water temperature to observe any effect on the cold-water stream. The students collect temperature data and measure flow rate that can be used in the heat co-efficient calculation, $q = mCp(\Delta T)$ and the overall heat coefficient calculation, $q = UAF \Delta T \ln$. (Table 1) was results typically obtained for most students, it can be noted the trending of the absorb duty moving from low temperature to the high temperature. The alarm on the cold system also appears due to the upper limit that was reach due to the heat absorption taken place through the tube walls. Another observation due to the increase in heat the overall heat co-efficiency (U) decrease as the temperature increases.

The theory the students were taught in a learning and teaching environment can then be applied by the students. This is done by interacting with 3D virtual process simulation software purchase from Petroskills-Simulation Solution LTD [12]. The students were task firstly to identify symbols on the Distributed Control System (DCS) and then identify the equipment and instruments in an outside view of the simulation program. The students are introduced to three digitalized simulation systems, heat exchange, fluid flow and centrifugal pumps. For this article the author wants to highlight the learning and teaching process for heat exchange. (Figure 3) shows the DCS for heat exchange, in this the student can manipulate the temperature of the Dowtherm oil and that of the cold water by controlling the flow rate of the fluids. Setpoints are set for the

VariableEvent	Cold In-let Flow FIC-100	Cold Inlet Temp TI-100	Hot Outlet Temp TIC-115	Hot Dowtherm Flow FIC-110	Hot Dowtherm Temp TI-135	Cold Dowtherm Temp TI-120	Material	Energy
INCREASE 10% Cold Flow FIC-100	↑	—	↗	↑	—	↗	↑	↑
DECREASE 5% Hot Temp TIC-115	—	—	↓	↓	—	↓	—	↓
Design Readings	FIC-100 16 M3/H	TI-100 29.40°C	TIC-115 40.5°C	FIC-110 37.4 ME/H	TI-135 60.0°C	TI-120 48.9°C		

Table 1: Temperature measurements in a heat exchange experiment.

Table 2: Illustrate a “what-if” scenario for 2 potential problems to be troubleshoot.

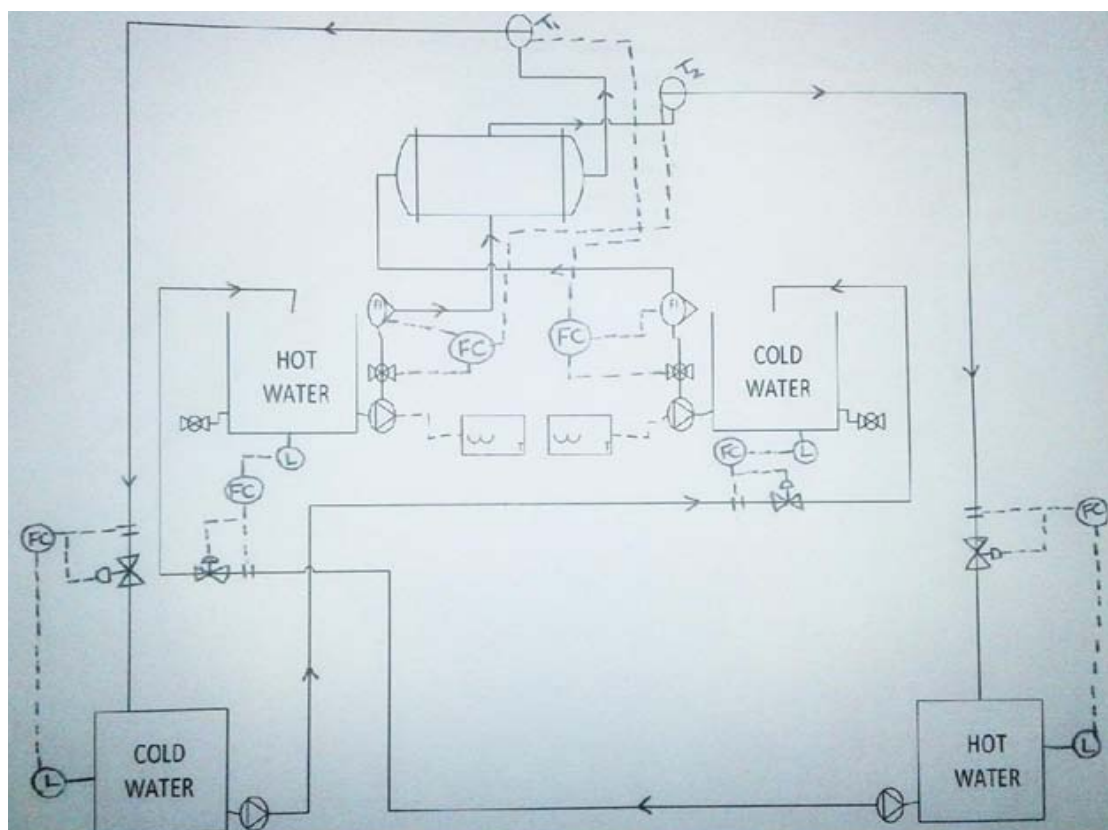

Figure 2: Student representation of a heat exchange system drawn in MS Visio.

various controllers. The upper and lower limits are set to in case of an abnormality that the alarms go off to warn the operator of possible consequence or event

Before the students start with the procedure for a cold start process they need to do predictions in the form of “What ifs” they start off by studying a possible defect, such as pump failure, valve fail open, valve fail close, and instrument failure. (Table 2) below is a typical scenario, the 1st what will happen if the cold flow increases

by 10%?, 2nd what will happen if temperature of the hot Dowtherm oil decreases by 5%?. The student needs to think about upstream and downstream aspects of the process, how this will affect the customer, and what risks are involved that need to be mitigated. This trains the students to use cognitive thinking to solve problems and to prepare them for a real work scenario where they need to solve a problem quickly and efficiently. Through this deductive reasoning with a quick glance a person can observe what could be affected upstream or in a downstream product.

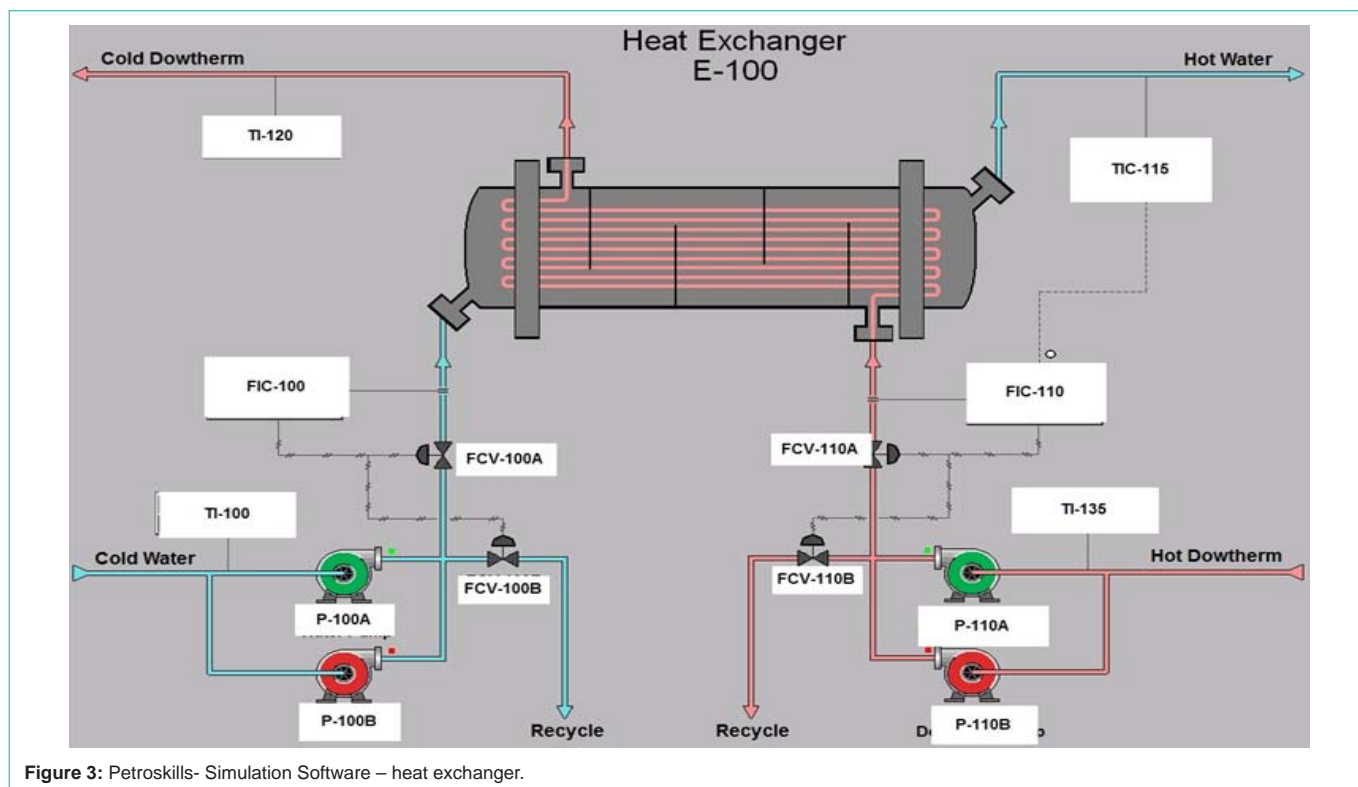

Figure 3: Petroskills- Simulation Software – heat exchanger.

In Table 2, two potential problems arise, the 1st, an increase of the flow rate of the cold water. This could be due to irregularities from a water source, or valve failing in open position. The black arrows introduce the problem that starts to occur. The student then predicts what would happen with cold inlet temperature and hot outlet temperature of the cold water through the heat exchanger, the flow and temperature can be observed on the Dowtherm oil side of the heat exchanger. Any fluctuation occurring with material or energy balances need to be recorded. This influence the thermodynamics and economics of the process.

Students Feedback Regarding the Process Simulation

Near the end of the semester the students were asked to participate in an anonymous survey and comment on what they thought was good or needed improvement in the presentation and execution of the process simulation. The number of students that participated were 25 students, overall, 84% of the students participated were satisfied with the workshop session on process simulation. The questionnaire consists of a combination of closed-ended questions that can only be answered by selecting from a limited number of options, using a multiple-choice question to rate the question in lowest to highest number or comment least describing the action taken. The questionnaire also contained open questions to provide an opportunity for the student to express themselves. For example, Section 2: Practical Session process simulation.

Q1: The instructions regarding the practical simulation training are:

Confusing	Insufficient	Clear	Very clear
-----------	--------------	-------	------------

Q2: The amount of time given to complete the workshop is:

Totally insufficient	Insufficient	Sufficient	Too much
----------------------	--------------	------------	----------

Q3: The amount of work covered in the simulation training is:

Totally insufficient	Insufficient	Sufficient	Too much
----------------------	--------------	------------	----------

Q4: The level of difficulty of the simulation training is:

Far too low	Low	Just right	Too high
-------------	-----	------------	----------

Q5: The theoretical study material with regard to the simulation training is:

Not applicable	Aometimes applicable	Usually applicable	Always applicable
----------------	----------------------	--------------------	-------------------

In the questionnaire there were 5 sections, dealing with 1) Section 2: the instruction regarding the practical simulation, 2) Section 3: Supervisor, 3) Section 4: Student interest, 4) Section 5: Overall rating and 5) open-ended questions.

Questions asked were as follows:

Q6: The lecturer offering the practical sessions is usually:

Q7: The lecturer offers the practical sessions usually in a:

Q8: The level of student participation which is allowed in class is:

Q9: The amount of feedback given to students is:

Q10: Student are usually treated:

Q11: Outside the normal practical sessions, the lecturer is:

Q12: As a student, I...

Open-ended questions

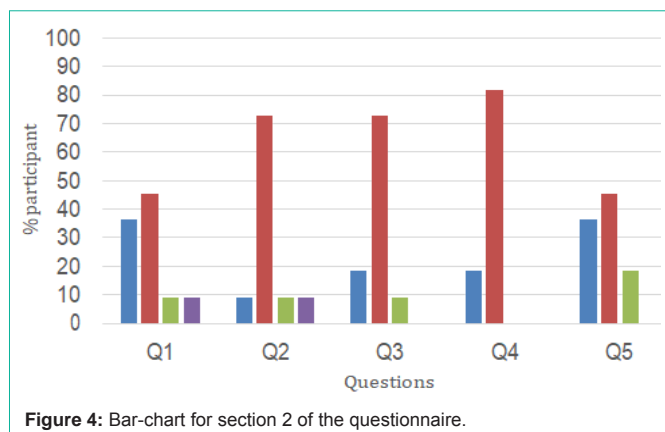

Figure 4: Bar-chart for section 2 of the questionnaire.

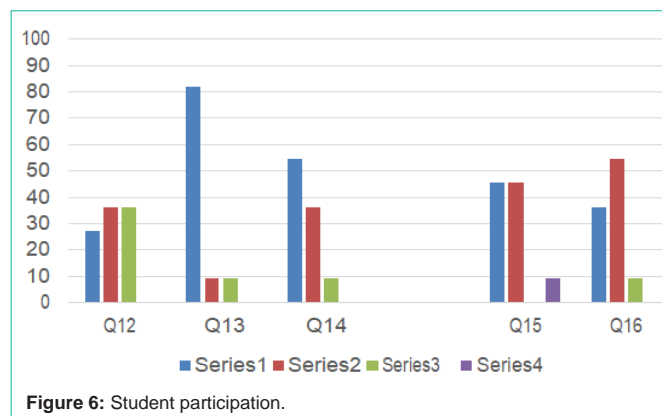

Figure 6: Student participation.

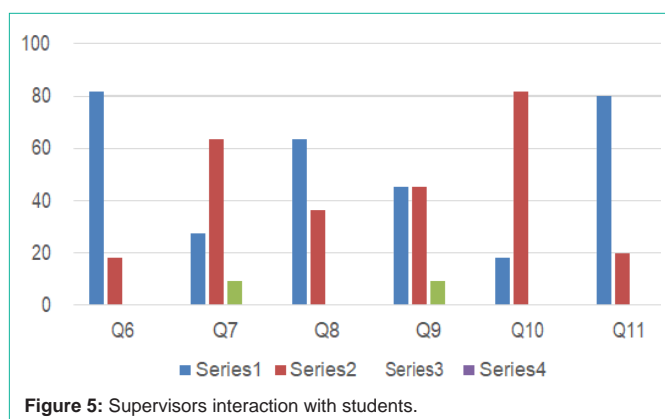

Figure 5: Supervisors interaction with students.

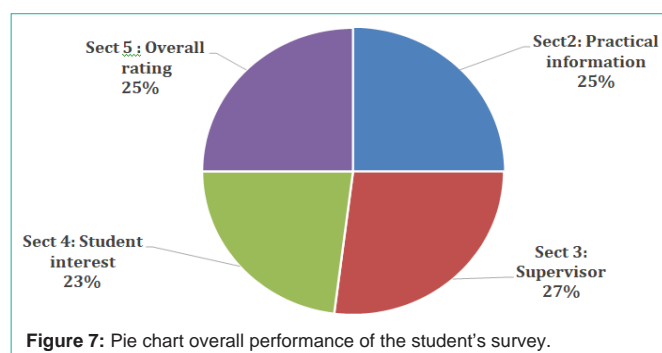

Figure 7: Pie chart overall performance of the student's survey.

- Q13: The practical training teaches me
- Q14: As a student, I probably will
- Q15: I rate my satisfaction with the simulation training as
- Q17: What aspects of simulation training were most valuable? Heat exchanger, fluid flow or centrifugal pumps
- Q18: What aspect of practical training was least valuable? Heat exchanger, fluid flow or centrifugal pumps
- Q19: What specific suggestions do you have to improve the simulator sessions?

Below are the bar-graphs obtained from the data captured through the questionnaire process. Blue – 4pts, red - 3points, green-2pts and purple -1pts. For example: Q1 very clear – 4, clear – 3, insufficient – 2 and confusing – 1.

Figure 4 shows a bar graph on the student's response for Section 2 of the questionnaire. The bar-chart shows that the instruction is clear and well understood by most of the students. Some of the students that mark this question low are normally struggling with language barriers and need more time to understand the context. In Q5 some students indicate that they struggled to connect the theoretical material with the simulation therefore, extra time need to be given to assist the slower students to catch up with the students that have a better cognitive thinking process.

In (Figure 5) the questions pertained to the performance of the supervisor/lecturer and the interaction with the students. This

section was answered very well, except for 1 or 2 students that felt that the feedback could be more detailed explained. All the students participated felt that the supervisor was knowledgeable on the subject matter and has a good demeanor with the students to assists students with the correct concepts to enhance their knowledge in process operations.

Figure 6 survey questions address student participation, the one alarming aspect is student participation the author found not all the student participate equally that could be because of their character or lack in knowledge. However, students are encouraged to develop a sense of “wonder” to be inquisitive and asked questions.

Students Feedback on Open-ended Euestions

“Comments: All aspects were valuable but the one that was the most valuable was the centrifugal pumps because in the company I am in we use a lot of pumps”

“Comments: For me it was Heat Exchanger as I was able to understand them fully. The other two fluid flow I could some of the things. Also, the centrifugal pumps where really helpful and gave me the understanding of Centrifugal pumps.”

” Comments:

The simulation process, the different scenarios a more practical approach should really considered in helping students understand what the terms and the grammar mean as this was challenging in doing the simulation.”

“Comments:

The aspects that were most valuable were Heat exchanger because

there was a lot of information given or I was able to learn a lot about it as well as it is easier to understand than the centrifugal pumps.”

Figure 7 below shows a Pie-chart with the overall performance of the student's survey for the 4 categories, 1) Practical information, 2) Supervisor, 3) Student interest and 4) overall rating. All the sectors were answered fairly and almost equally distributed.

All these simulations were performed during Covid19 lockdown regulation this made it difficult for the student lecturer to interact. [14] Online simulations were difficult and challenging since the students try and do this on their own with assistance from the lecturer on an online platform. Once the students have understood the concepts and how the simulation software works the operation becomes much smoother and the students interact much better with the simulation software to run the various chemical-plant equipment.

Future Work

As the process simulation course is offered every year, future work to optimize the simulation sessions in the light of the feedback obtained includes the following:

- Provide better clarity and pre-presentation on what is expected in the simulation workshop.
- Provide more and efficient time to allow students to interact with the process simulation and as for flight.
- Simulation need plant operation time to enhance skills and to recognized potential faults that might occur in normal operations.
- Add more lecture time to discuss in learn and teaching session on process control and plant simulations.

Conclusions

Process simulation is vital tool for students to learn how to navigate their way through a process plant, although the three modules chosen, heat exchange, fluid flow and centrifugal pumps it is important for students to comprehend the theories taught in a lecture and implement these theories in a practical manner. From the analysis of the survey feedback, most of the students consider the process simulation workshop are helpful and effective in their preparedness for industry. Future improvements are planned to optimize the workshop sessions. To provide more simulation time to the students to fully comprehend the process troubleshooting, cold starts, shutdowns and reading trending charts to mitigate any potential risk to the process or environment.

Acknowledgements

The author thanks Nelson Mandela University for their support of the Diploma in Chemical Process Technology programme. Funding

made available through Nelson Mandela University Council, and Teaching Development Initiative Fund and AECI Community Trust which enabled the learning to continue in benefiting this training towards students.

Declaration of Competing Interest

The authors declare that they have no known competing financial interests or personal relationships that could have appeared to influence the work reported in this paper.

References

1. Bergamo PA, Streng ES, De Carvalho MA, Rosenkranz J, Ghobani Y. Simulation-based training and learning: A review on technology enhanced education for the minerals industry. *Minerals Engineering*. 2022; 175: 107272.
2. Casavant TE, Côte RP. Using Chemical process simulation to design industrial ecosystems. *Journal of cleaner production*. 2004; 12: 901-908.
3. Zhang Y, Munir MT, Yu W, Young BR. A real time approach to process control education with an open-ended simulation tool. *Education for Chemical Engineers*. 2013; 8: e105-e112.
4. Lewin DR, Barzilai A. The flip side of teaching process design and process control to chemical engineering undergraduates – and completely online to boot. *Education for Chemical Engineers*. 2022; 39: 44-57.
5. Lapitan LDS, Tiangco CE, Sumalinog DA, Sabarillo NS, Diaz JM. An effective blended online teaching and learning strategy during the Covid-19 pandemic. *Education for Chemical Engineers*. 2021; 35: 116-131.
6. AlMetwally SAH, Hassan MK, Mourad MH. Real Time Internet of Things (IoT) based water quality management System. *Procedia CIRP*. 2020; 91: 478-485.
7. Tsang YP, Lee CKM. Artificial intelligence in industrial design: A Semi-automated literature survey. *Survey paper*. 2022; 112: 104884.
8. Kawamura ML, Alleyne AG. A simulation and experimental environment for teaching chemical reaction process control dynamics and control. *IFAC Papers online*. 2017; 50: 15692-15697.
9. Kale U, Akcaoglu. Problem solving and Teaching How to solve Problems in Technology – Rich contexts. *Peabody Journal of Education*. 2020; 95: 127-138.
10. Arunraja A, Jayanthi. Tuning methods of various controllers. *Materials Today: Proceedings*. 2020; 67.
11. Gouws S. Teaching for chemical process technicians. *Education for chemical engineers*. 2022; 39: 6-14.
12. Garvey M. *PetroSkills – Simulation Solutions LTD*. New Jersey. USA. 2022. <https://www.petroskills.com/solutions/console-operator-training>
13. Pump characterization experiment: 2022. <http://site.iugaza.edu.ps/mymousa/files/Experiment-9-4-hydraulics-lab-21.pdf>
14. Teele SA, Sindelar A, Brown D, Kane DA, Thatte N, Williams RJ, et al. Online education in a hurry: Delivering pediatric graduate medical education during COVID-19. *Progress in Pediatric Cardiology*. 2021; 60: 101320.